

DIRECTOR OFFICE ( OPTION B)

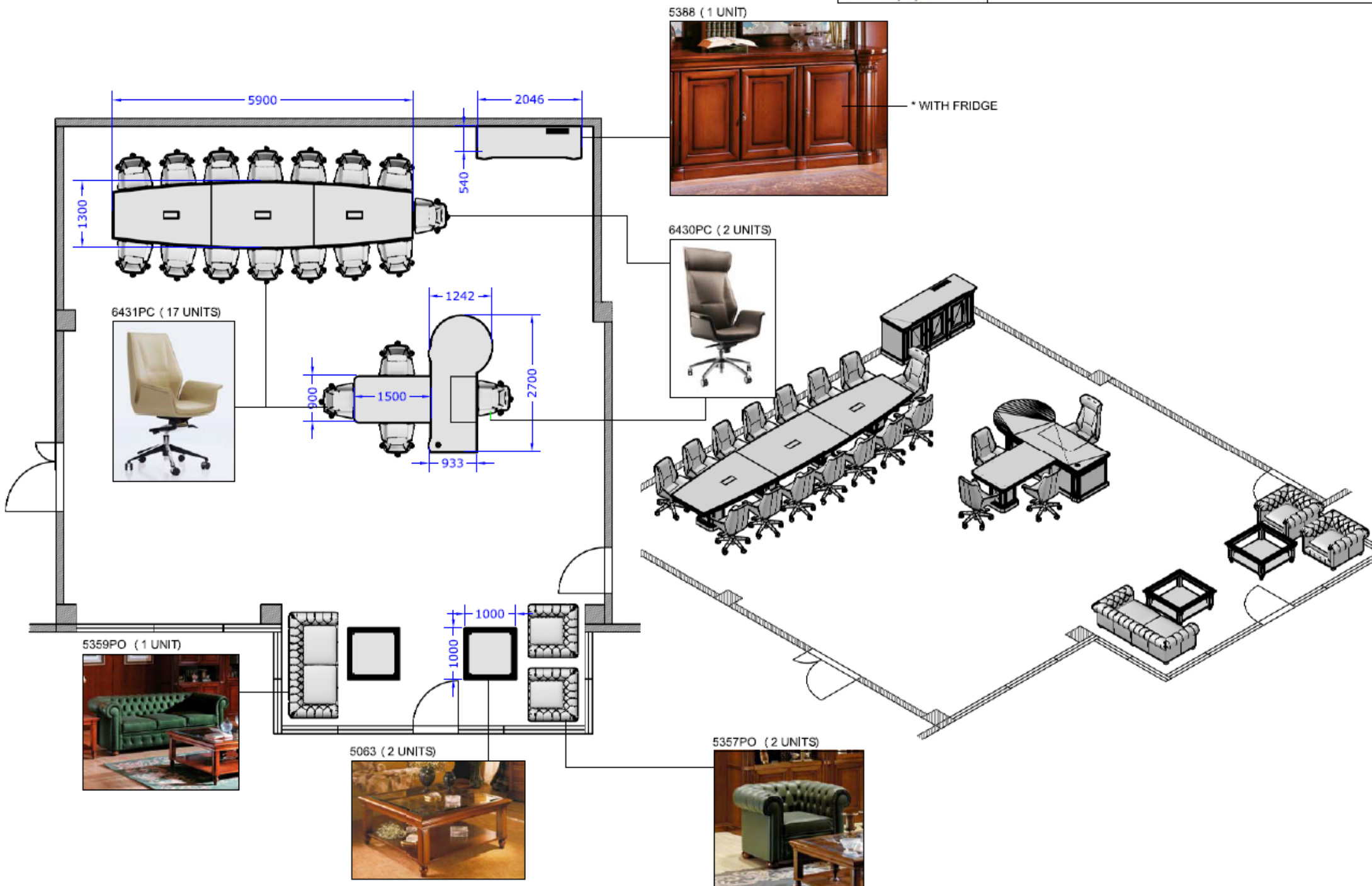

**DIRECTOR OFFICE (OPTION A)**

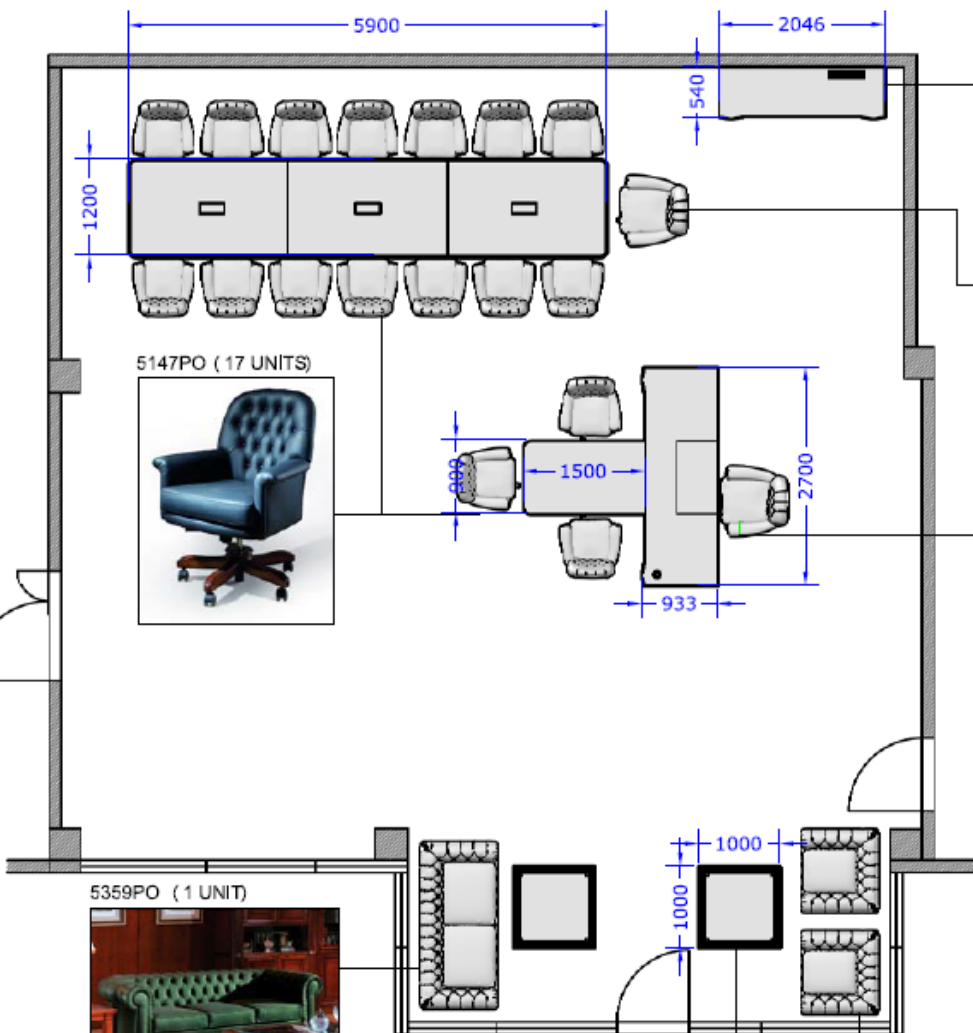

5388 (1 UNIT)

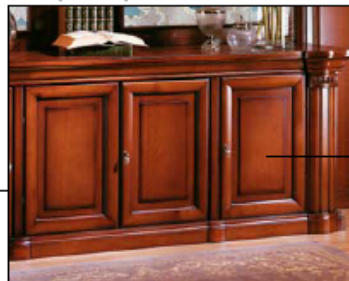

\* WITH FRIDGE

5152PO (2 UNITS)

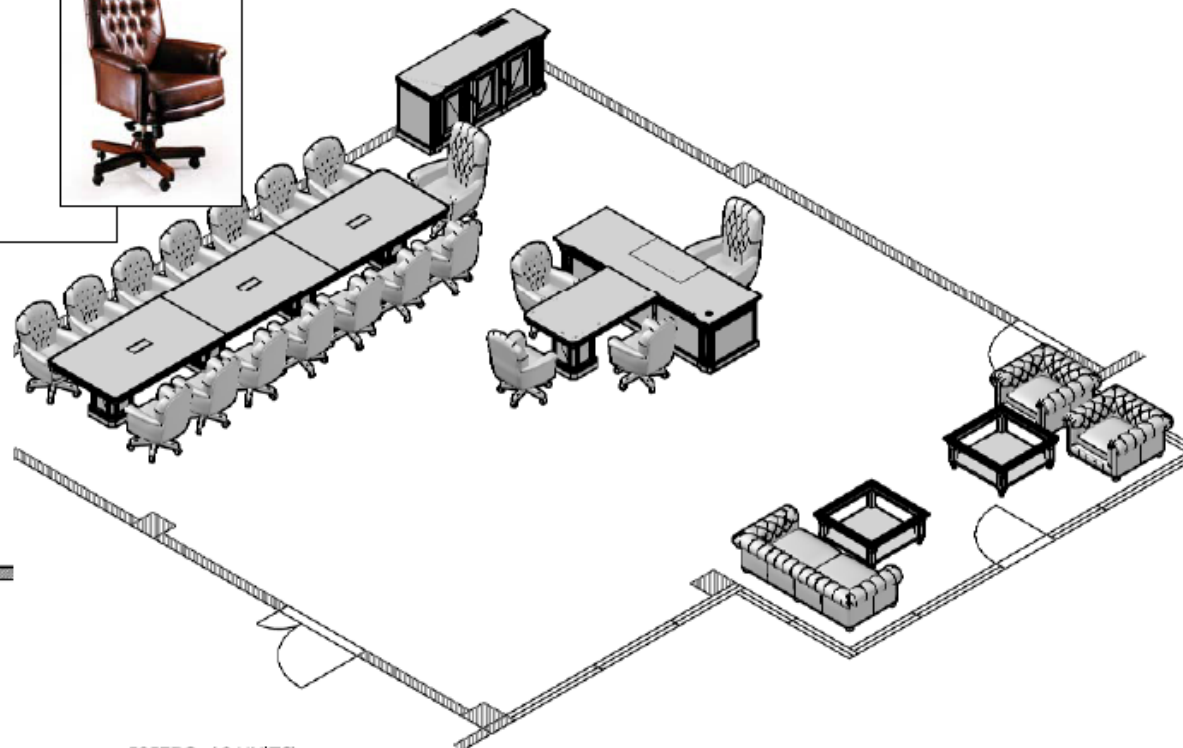

5359PO (1 UNIT)



5063 (2 UNITS)



5357PO (2 UNITS)



MEETING TABLE 5900x1200x771 H SENATOR

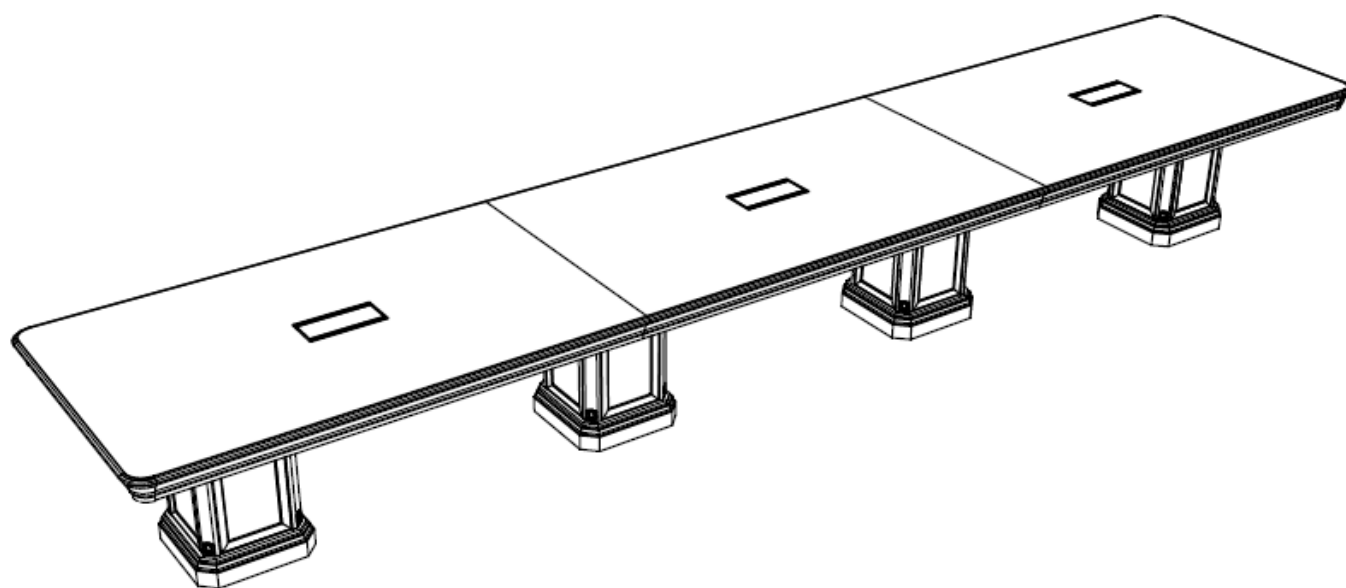
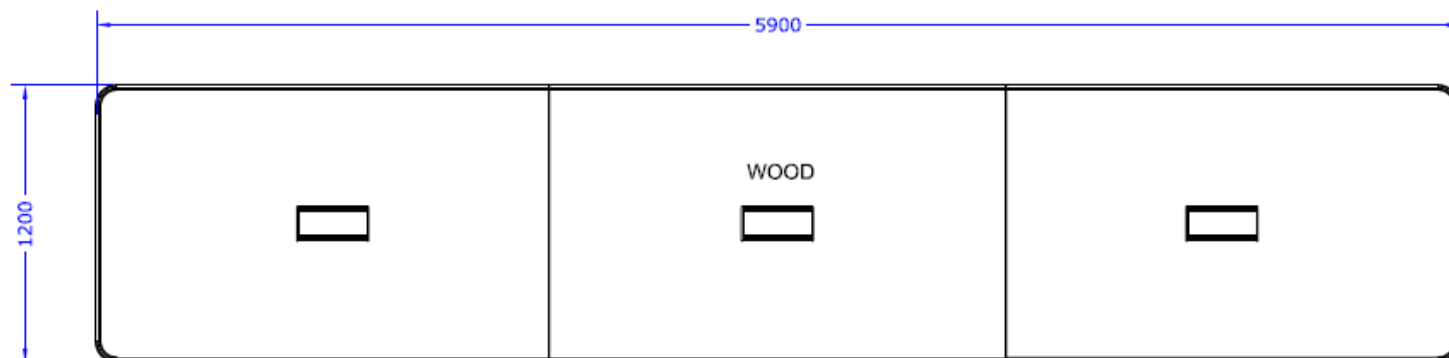
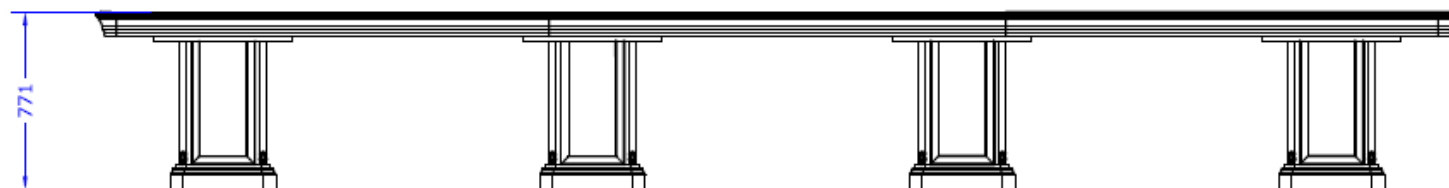

DESK 2700x767 H SENATOR

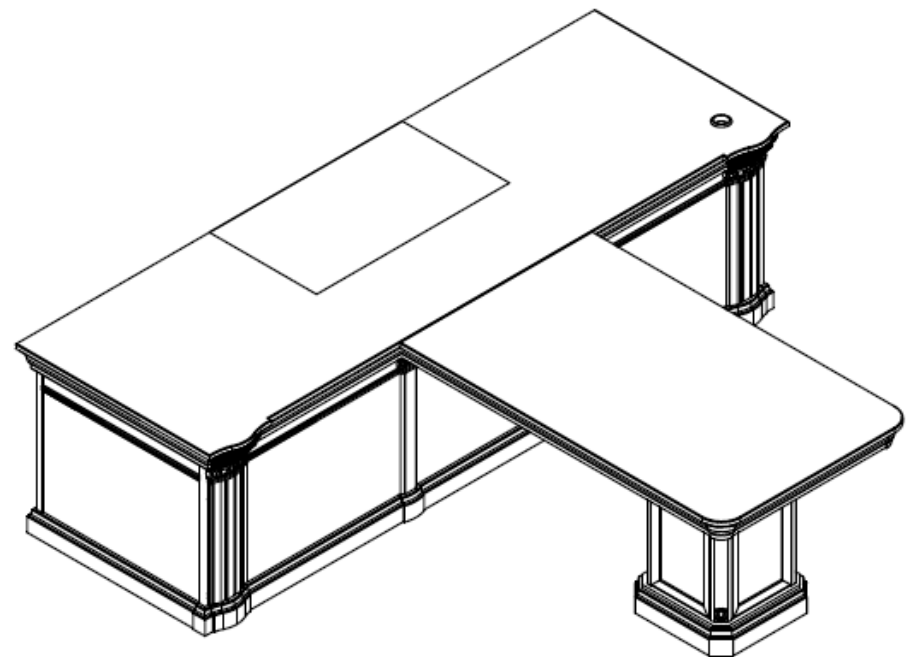
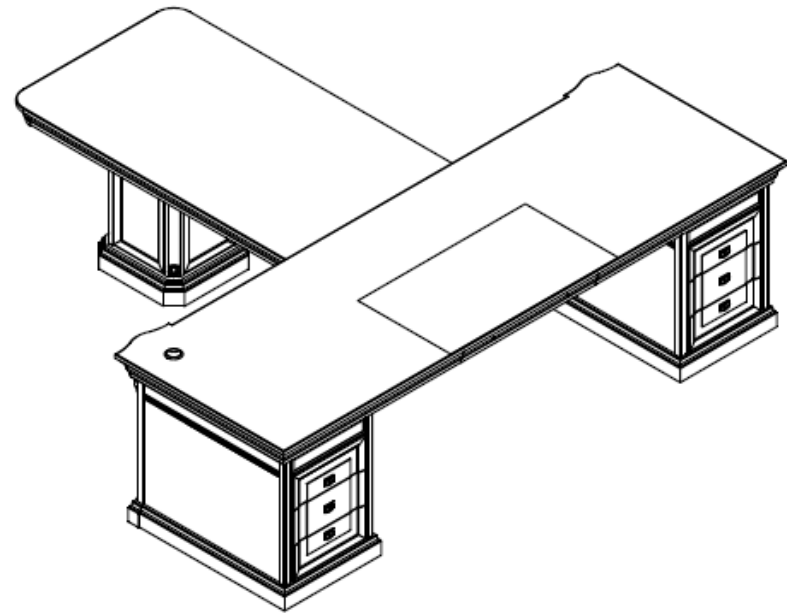
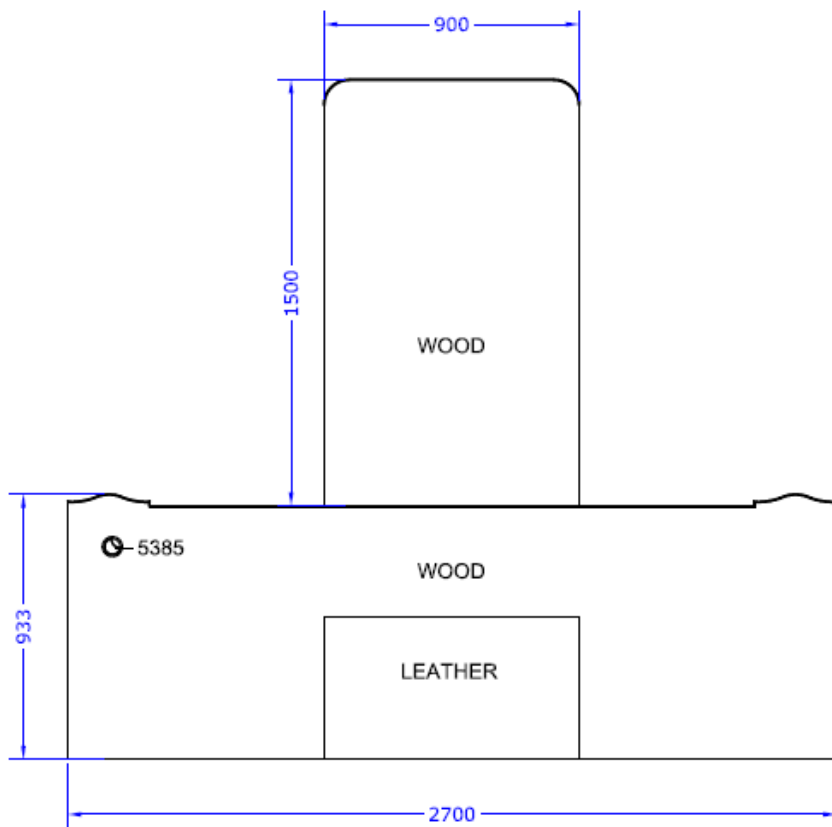
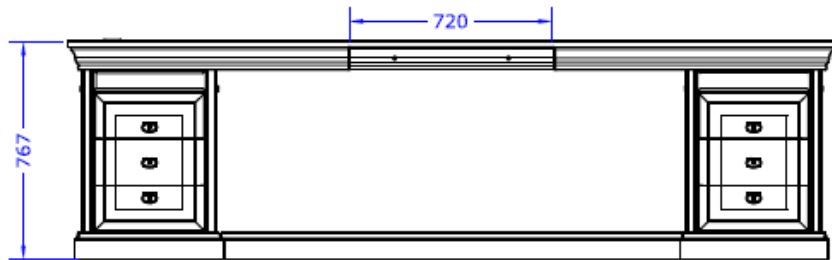

MEETING TABLE 5900X1300/900 SENATOR- BOAT SHAPE

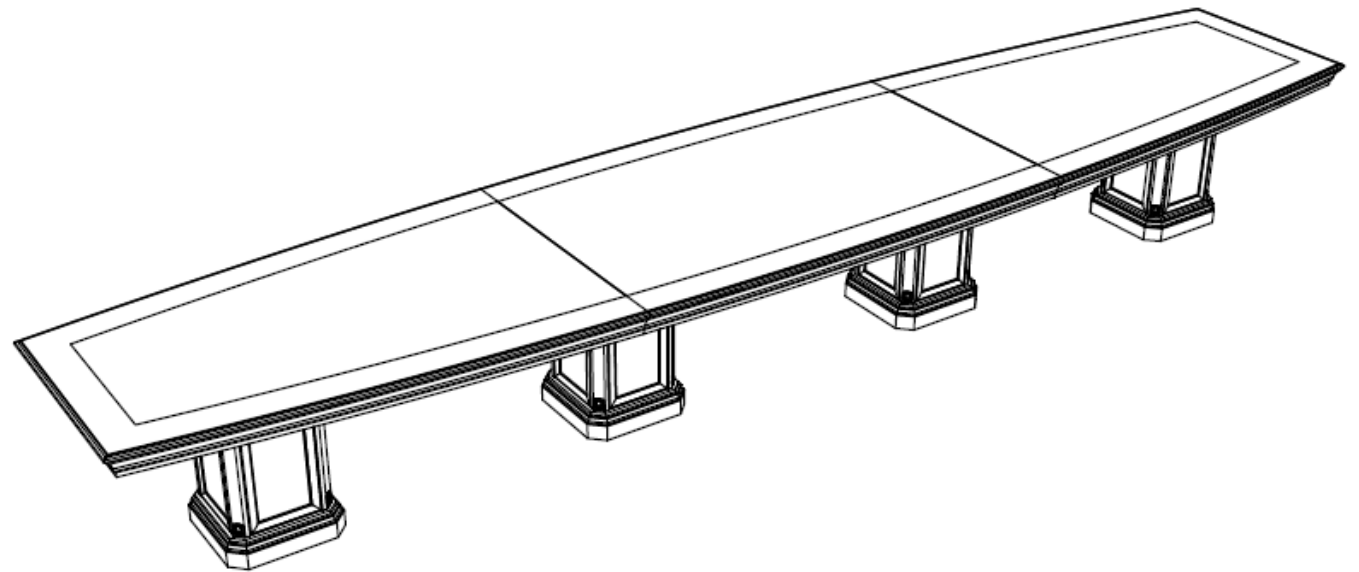
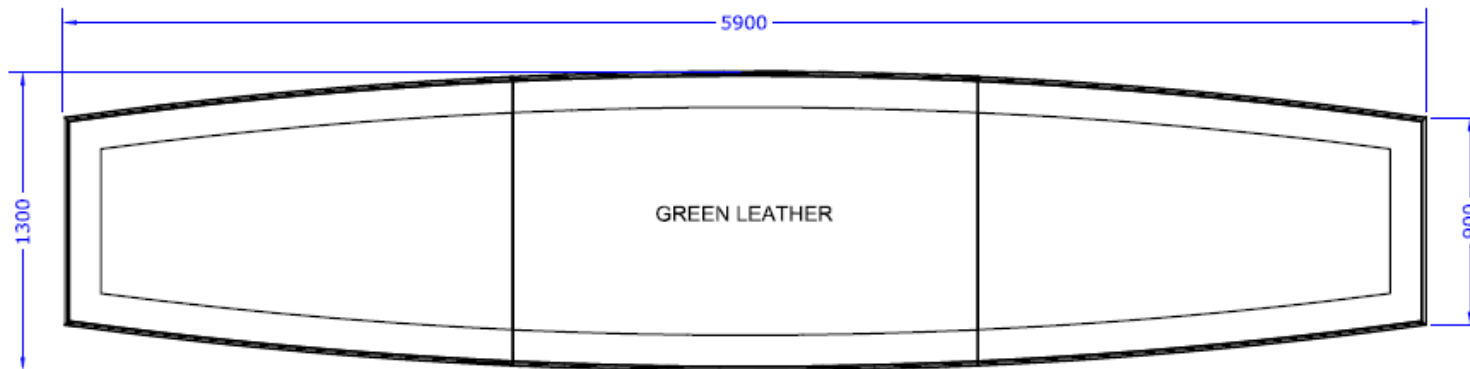
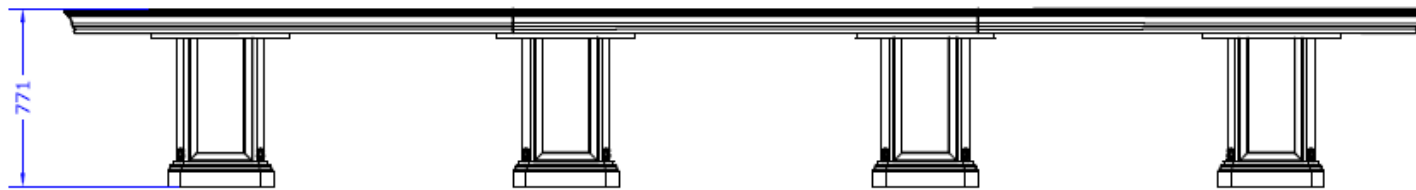

DESK 2700x767 H SENATOR

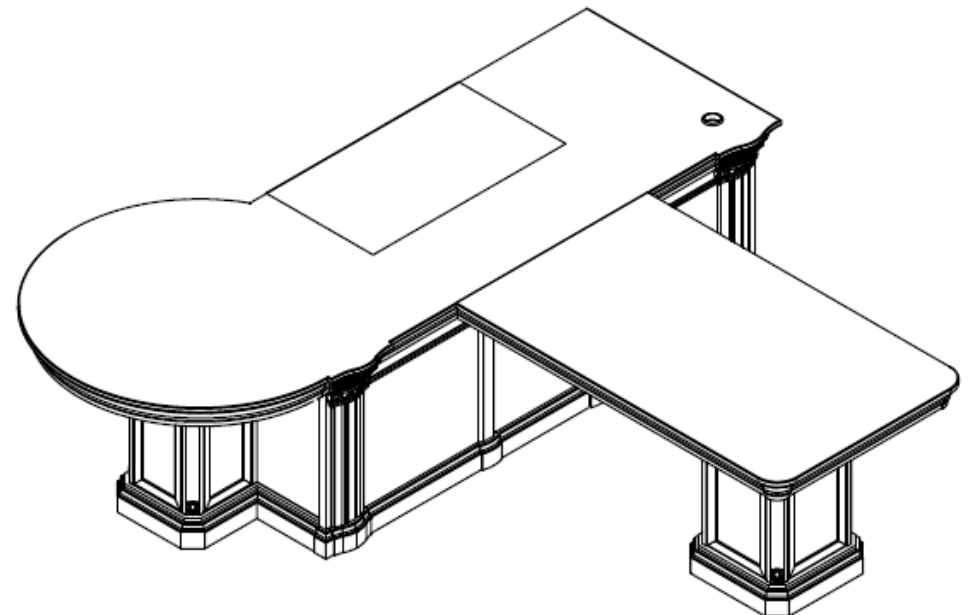
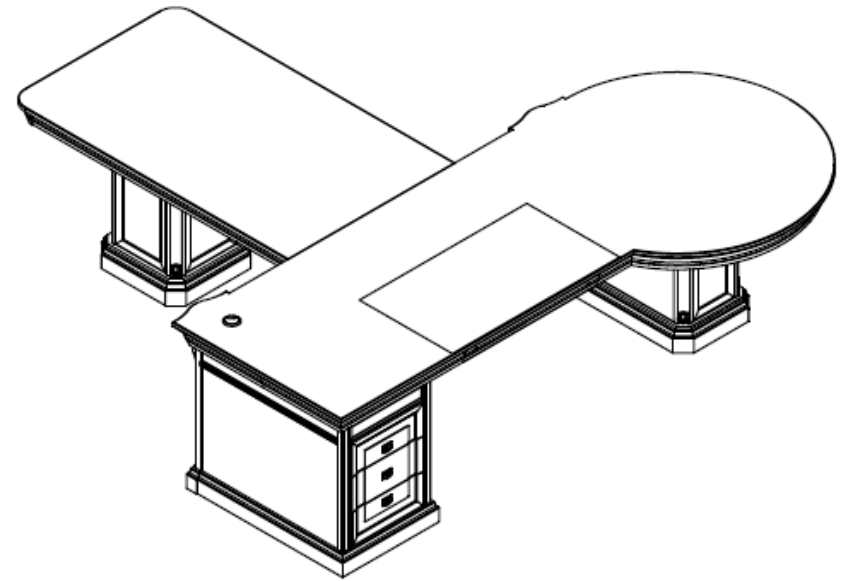
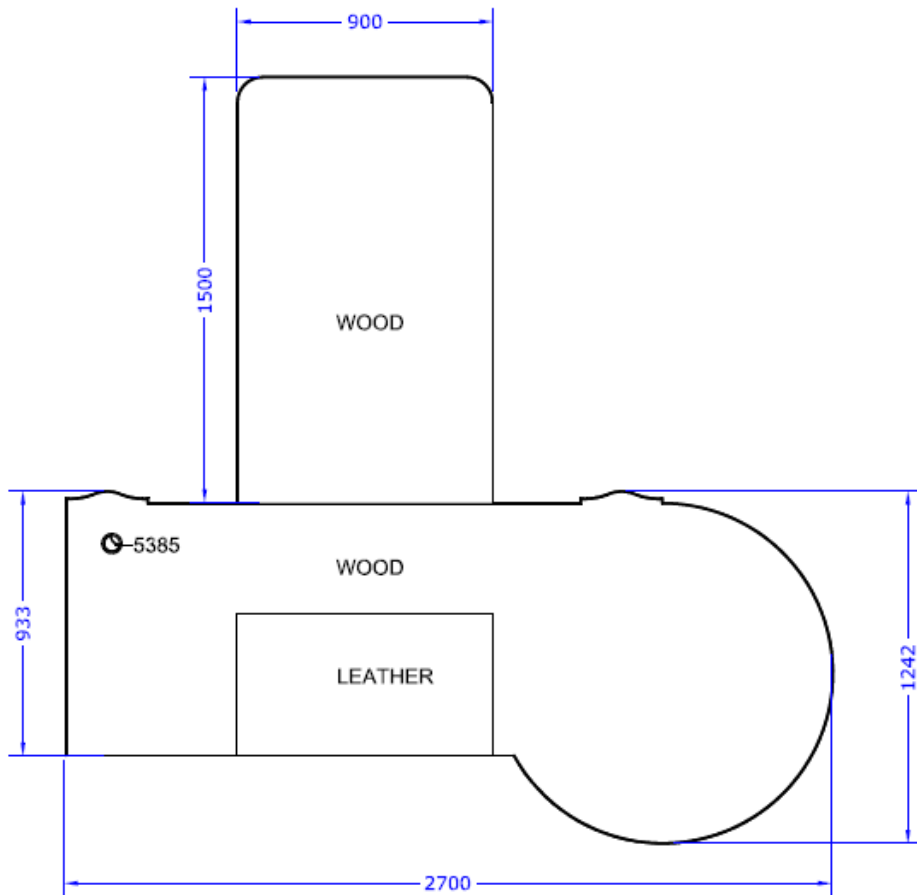
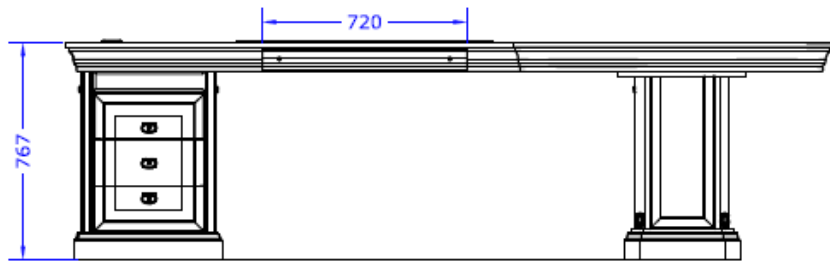

REST ROOM

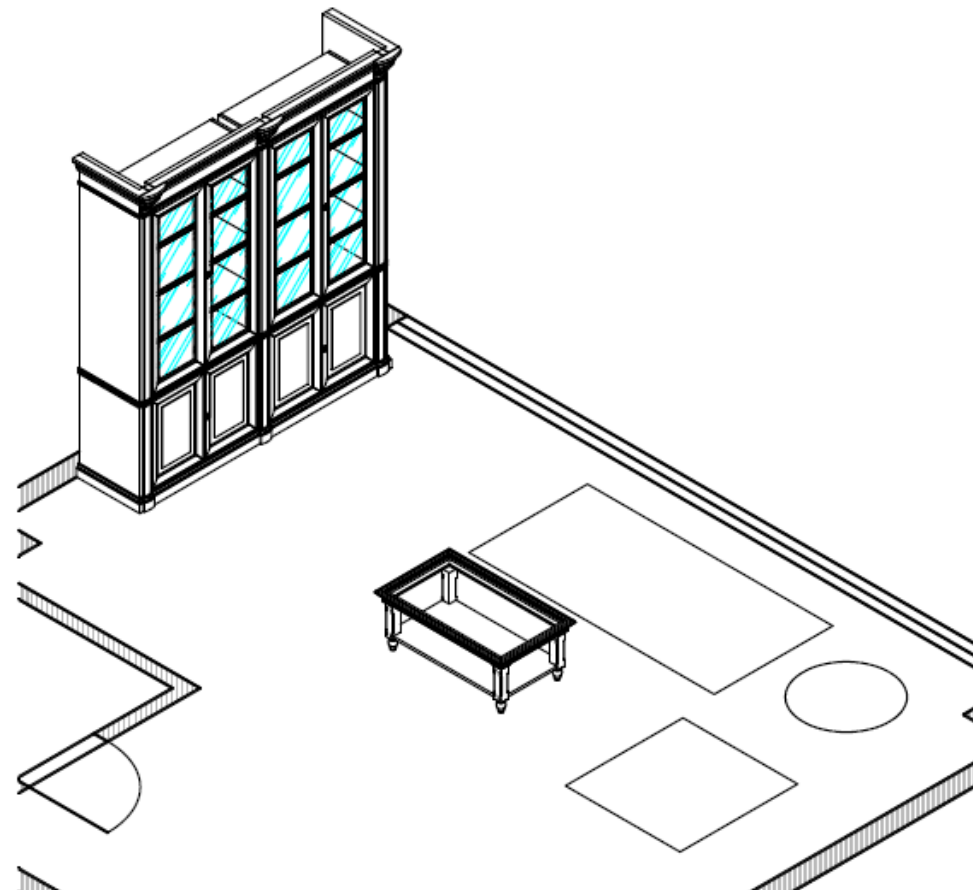
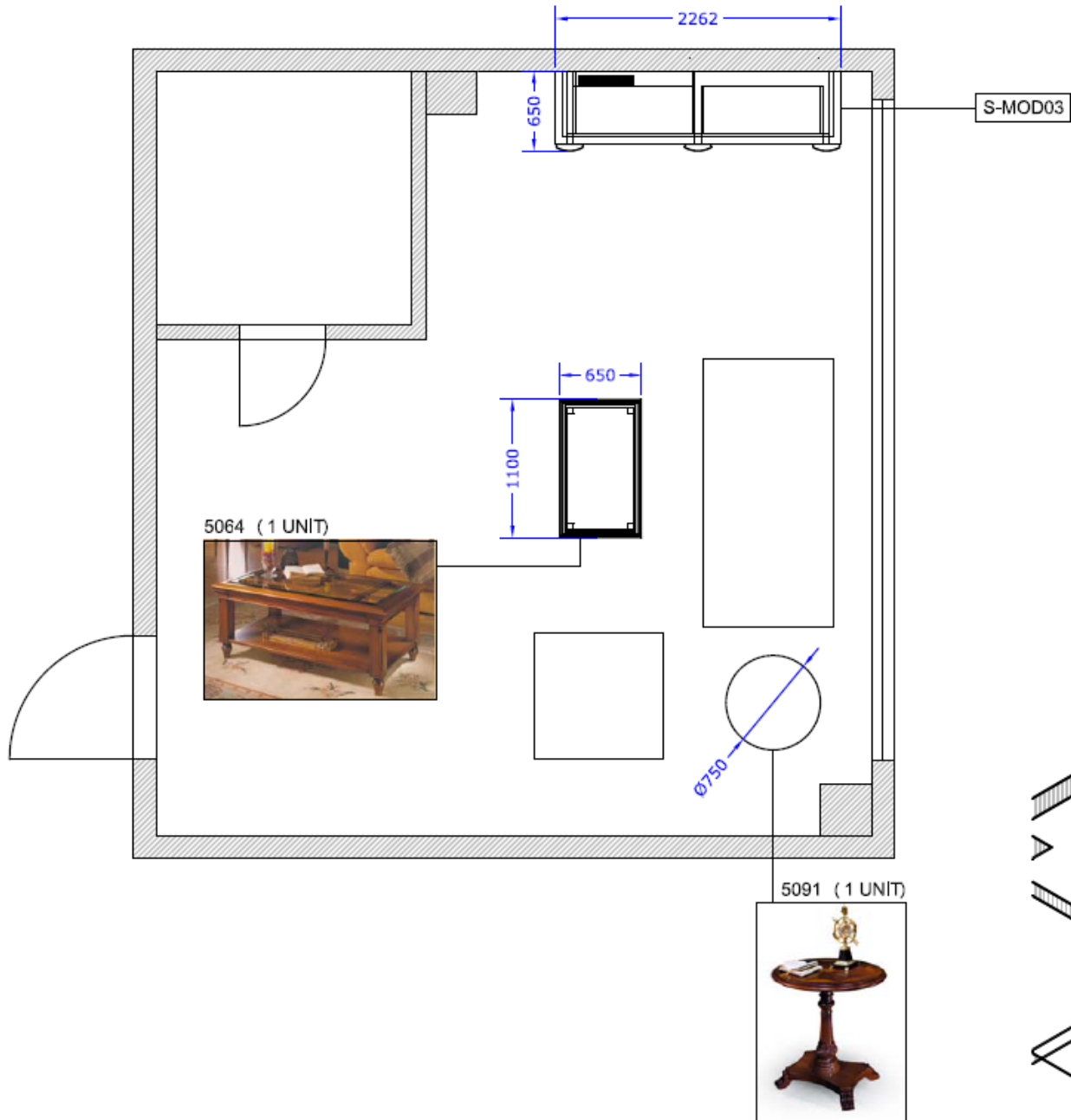

S-MOD03

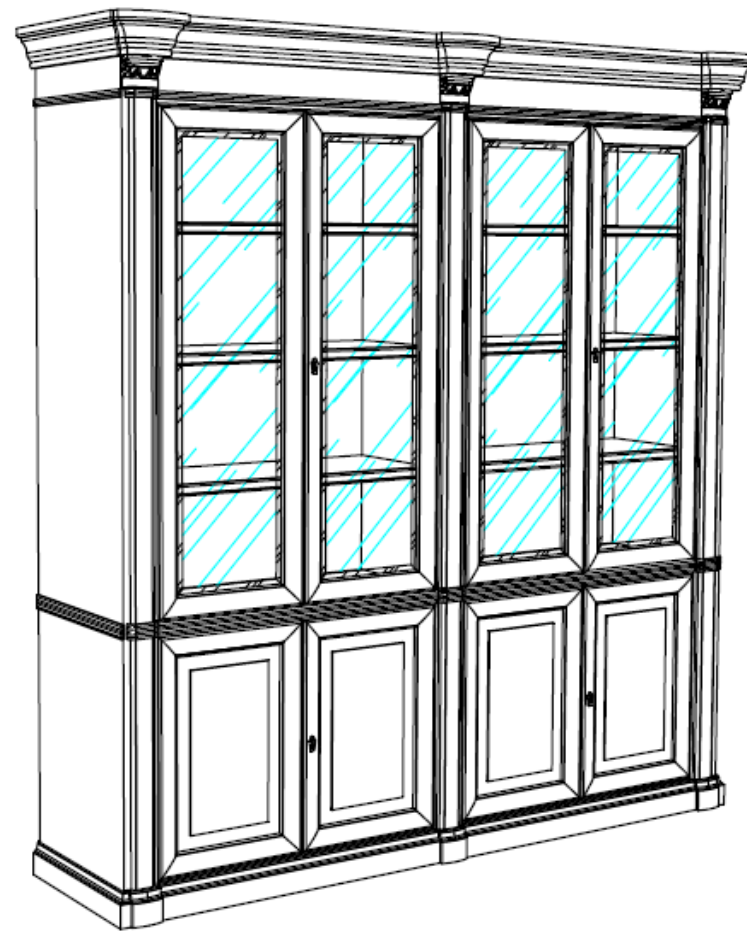
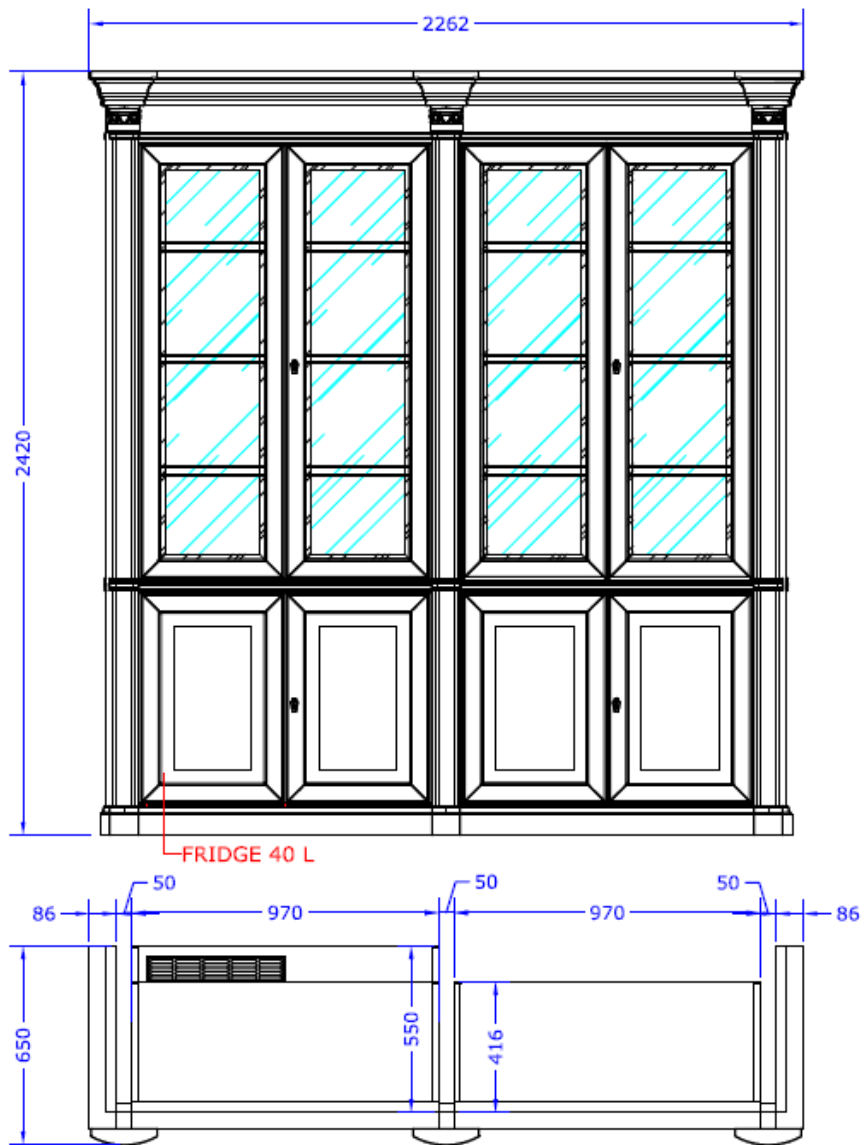



## ОСНАЩЕНИЕ ПОМЕЩЕНИЙ 203, 204, 205, 207

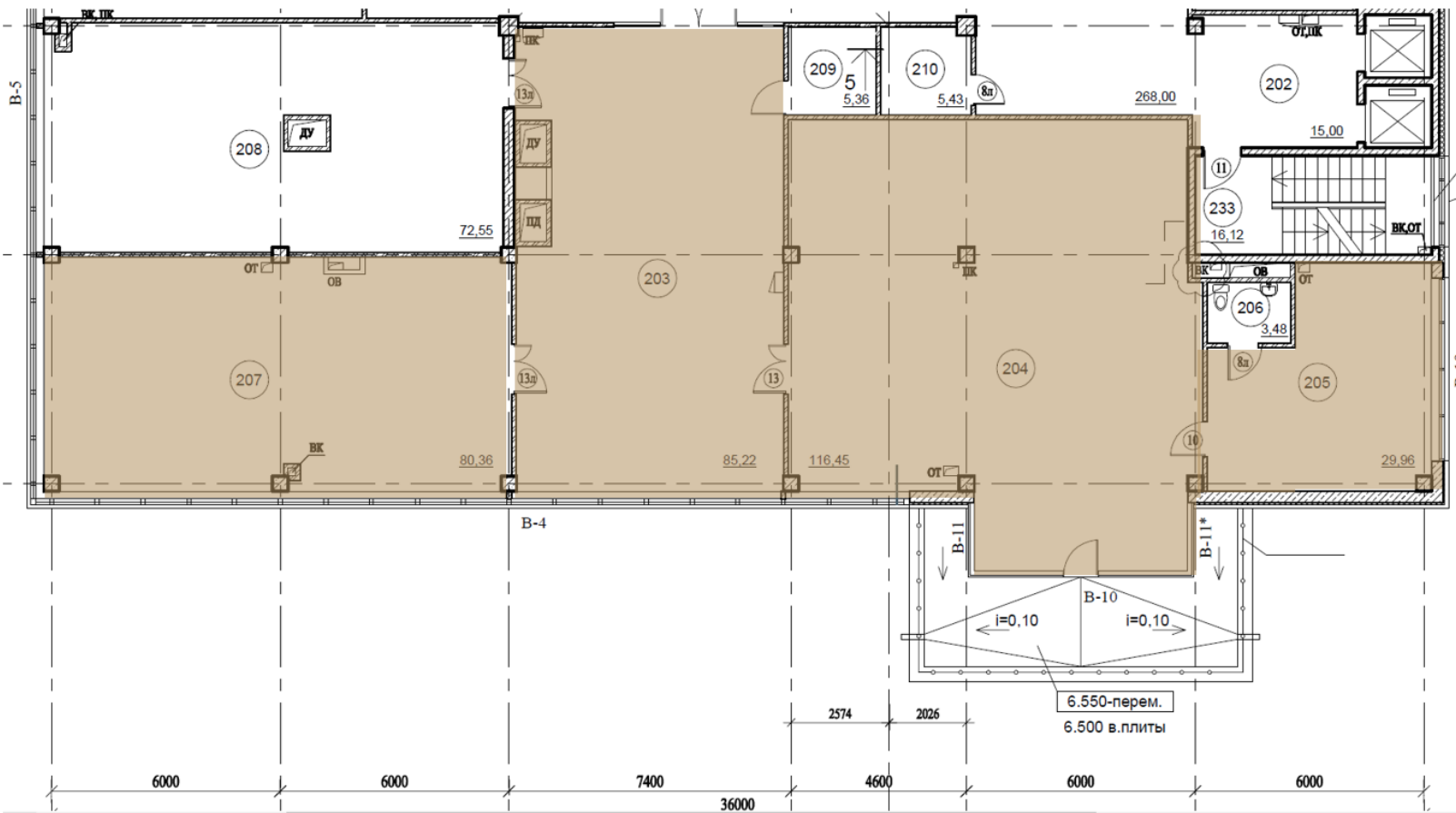

Экспликация помещений 2 этажа

№ пом.	Наименование	Пло м2
201	Холл	268,00
202	Лифтовой холл	15,00
203	Приемная	85,22
204	Кабинет ген. директора	116,45
205	Комната отдыха	29,96
206	Сан. узел	3,48
207	Переговорная	72,55
208	Кабинет первого заместителя	80,36